



DIRIS A20

Multifunction meters - PMD

Multi-measurement meter - dimensions 3.78 x 3.78 in/96 x 96 mm

Single-circuit metering,
measurement &
analysis



DIRIS A20

The solution for

- > Industry
- > Infrastructure
- > Data centres



Strong points

- > Easy to use
- > Compliant with ANSI C12.20 and IEC 61557-12
- > Detects wiring errors

Conformity to standards

- > UL 61010
File E257746
- > ANSI C12.20
- > IEC 61557-12
- > IEC 62053-22
class 0.5S
- > IEC 62053-23
class 2



Management software

- > To get the most effective use from your Socomec measurement and metering devices, we offer a range of dedicated software tools. See page 64.

Function

DIRIS A20 are panel mounted measurement units which ensure the user has access to all the measurements required for successfully carrying out energy efficiency projects and ensuring the electrical distribution is monitored. All this information can be analyzed remotely using the software solution.

Advantages

Easy to use

Thanks to its large backlit LCD display and its multiple viewing screens with direct pushbutton access, DIRIS A20 provide clear readings and are easy to use.

They directly display a number of multi-measurement and metering values : + kWh, + kvarh, I, U, V, F, P, Q, S, PF, etc.

Compliant with ANSI C12.20 and IEC 61557-12

IEC 61557-12 is a high-level standard for all PMDs (Performance Monitoring Devices) that are designed to measure and monitor electrical parameters in distribution networks.

Compliance with IEC 61557-12 ensures a high level of equipment performance, in terms of metrology, and the mechanical and environmental aspects (EMC, temperature, etc.).

Principle diagram

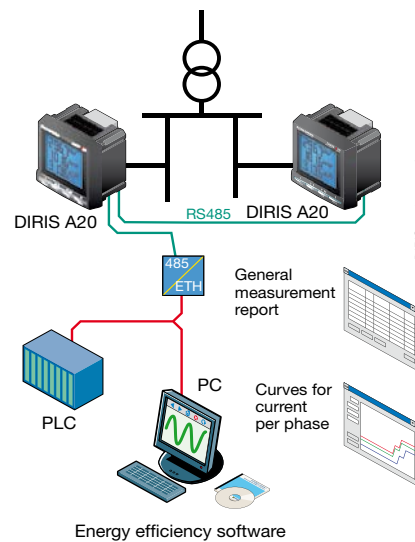

Detects wiring errors

An integrated test function can be utilized to detect incorrect wiring and to automatically correct CT installation errors.

Functions

Multi-measurement

- Currents
 - instantaneous: I1, I2, I3, In
 - maximum average: I1, I2, I3, In
- Voltages & frequency
 - instantaneous: V1, V2, V3, U12, U23, U31, F
- Power
 - instantaneous: 3P, ΣP, 3Q, ΣQ, 3S, ΣS
 - maximum average: ΣP, ΣQ, ΣS
- Power factors
 - instantaneous: 3PF, Σ

Metering

- Active energy: + kWh
- Reactive energy: + kvarh
- Hours: ⌚

Harmonic analysis

- Total harmonic distortion (level 51)
 - Currents: thd I1, thd I2, thd I3
 - Phase-to-neutral voltage: thd V1, thd V2, thd V3
 - Phase-to-phase voltage: thd U12, thd U23, thd U31

Events

Alarms on all electrical values

Communications⁽¹⁾

RS485 with MODBUS protocol

Output

- Remote command of device
- Alarm report
- Pulse report

Inputs

- Remote status device

(1) Available as an option (see the following pages).

Front panel



1. Backlit LCD display.
2. Direct access key for currents (instantaneous and max. values), current THD and test function.
3. Direct access key for voltages, frequency and voltage THD.
4. Pushbutton for active, reactive, and apparent power (instantaneous and max. values) and power factor.
5. Direct access key for energies, hour meter and programming menu.

Case

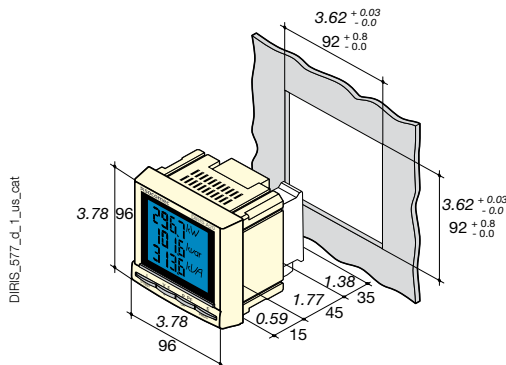

| | |
|--|---|
| Type | panel mounting |
| Dimensions W x H x D | 3.78 x 3.78 x 2.36 in / 96 x 96 x 60 mm |
| Case degree of protection | IP30 |
| Front degree of protection | IP52 |
| Display type | backlit LCD display |
| Terminal block type | Fixed or plug-in |
| Voltage and other connection cross-section | AWG 34 ... 10 / 0.2 ... 2.5 mm ² |
| Current connection cross-section | AWG 20 ... 9 / 0.5 ... 6 mm ² |
| Weight | 14.11 oz / 400 g |

Plug-in modules

DIRIS® A20



1 Output

- 1 output assignable to:
- Pulses: configurable (type, weight, duration) in kWh or kvarh.
 - Monitoring: 3I, In, 3V, 3U, F, ΣP, ΣQ, ΣS, ΣPFL/C, THD 3I, THD 3V, THD 3U and timer.
 - Remote command of device.



Communication

RS485 link with JBUS / MODBUS protocol (speed up to 38400 bauds)



3 inputs, 1 output

- 3 inputs assignable to:
- Remote status device.
- 1 output assignable to:
- Pulses: configurable (type, weight, duration) in kWh or kvarh.
 - Monitoring: 3I, In, 3V, 3U, F, ΣP, ΣQ, ΣS, ΣPFL/C, THD 3I, THD 3V, THD 3U and timer.
 - Remote command of device.

Accessories

UL recognized Current Transformers (see page 56)



IP65 protection



Panel mounting kit for a 144 x 96 mm cut-out



DIRIS A20

Multifunction meters - PMD

Multi-measurement meter - dimensions 3.78 x 3.78 in/96 x 96 mm

Electrical characteristics

| Current measurement (TRMS) | |
|--|---------------------------|
| Via CT primary | 9 999 A |
| Via CT secondary | 5 A |
| Measurement range | 0 ... 11 kA |
| Input consumption | 0.6 VA |
| Measurement updating period | 1 s |
| Accuracy | 0.2 % |
| Permanent overload | 6 A |
| Intermittent overload | 10 I _n for 1 s |
| Voltage measurements (TRMS) | |
| Direct measurement between phases | 50 ... 500 VAC |
| Direct measurement between phase and neutral | 28 ... 289 VAC |
| Input consumption | ≤ 0.1 VA |
| Measurement updating period | 1 s |
| Accuracy | 0.2 % |
| Permanent overload | 800 VAC |
| Power measurement | |
| Measurement updating period | 1 s |
| Accuracy | 0.5 % |
| Power factor measurement | |
| Measurement updating period | 1 s |
| Accuracy | 0.5 % |
| Frequency measurement | |
| Measurement range | 45 ... 65 Hz |
| Measurement updating period | 1 s |
| Accuracy | 0.1 % |

| Energy accuracy | |
|--------------------------------------|--------------------------------------|
| Active (according to IEC 62053-22) | Class 0.5 S |
| Reactive (according to IEC 62053-23) | Class 2 |
| Auxiliary power supply | |
| Alternating voltage | 110 ... 240 VAC |
| AC tolerance | ± 10 % |
| Direct voltage | 120 ... 250 VDC |
| DC tolerance | ± 20 % |
| Frequency | 50 / 60 Hz |
| Consumption | 10 VA |
| Pulse or alarm output | |
| Number | 1 |
| Type | 100 VDC - 0.5 A - 10 VA |
| Max. number of operations | ≤ 10 ⁸ |
| Inputs | |
| Number | 3 |
| Power supply | 10 ... 30 VDC |
| Minimum signal width | 10 ms |
| Minimum duration between 2 pulses | 18 ms |
| Type | Phototransistors |
| Communication | |
| Link | RS485 |
| Type | 2 ... 3 half duplex wires |
| Protocol | MODBUS RTU |
| MODBUS [®] speed | 1400 ... 38400 bauds |
| Operating conditions | |
| Operating temperature | - 10 ... +55 °C / +14 °F ... +131 °F |
| Storage temperature | - 20 ... +85 °C / -4 °F ... +185 °F |
| Relative humidity | 95 % |

Terminals

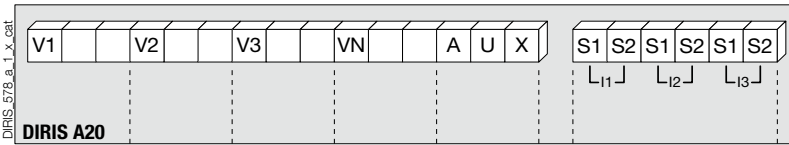

S1 - S2: current inputs.

AUX: auxiliary power supply U_s.
V1, V2, V3 & VN: voltage inputs.

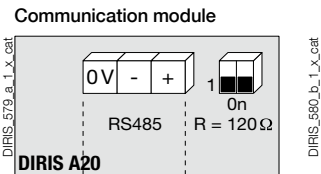

RS485 link.
R = 120 Ω: selectable internal resistance for RS485 end of line termination.

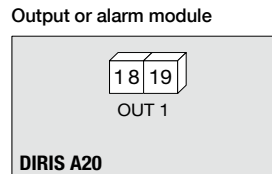

18 - 19: output n°1

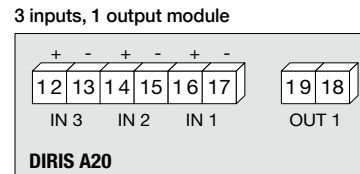

Connection

Recommendation:

- For IT earthing systems, it is recommended that the CT secondary is not connected to earth.
- When disconnecting the DIRIS, the secondary of each current transformer must be short-circuited. This operation can be carried out automatically by a SOCOMEC PTI, an accessory which is included in this catalogue. Please consult us.

Low voltage balanced network

3/4 wires with 1 CT

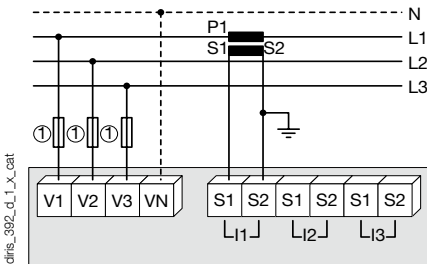

Use of 1 CT reduces by 0.5% the accuracy of the phases, the current of which is worked out by vector calculation.
1. Fuses 0.5 A gG / 0.5 A class CC.

Single-phase

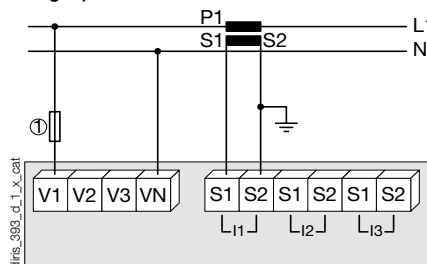

1. Fuses 0.5 A gG / 0.5 A class CC.

Two-phase

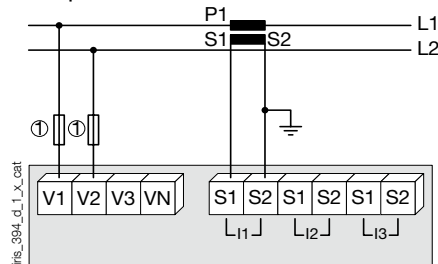

1. Fuses 0.5 A gG / 0.5 A class CC.

Low voltage unbalanced network

3/4 wires with 3 CTs

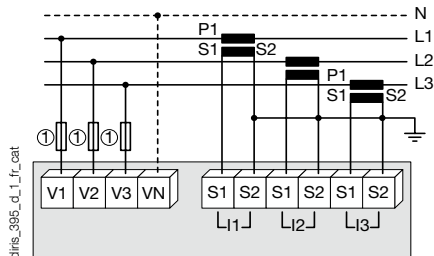

1. Fuses 0.5 A gG / 0.5 A class CC.

3 wires with 2 CTs

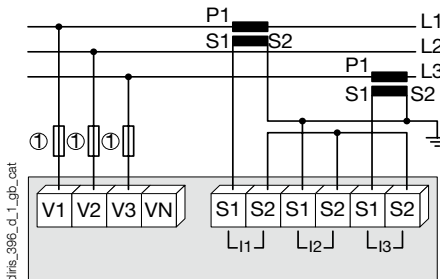

Use of 2 CTs reduces by 0.5% the accuracy of the phases, the current of which is worked out by vector calculation.

1. Fuses 0.5 A gG / 0.5 A class CC.

3 wires with 2 CTs

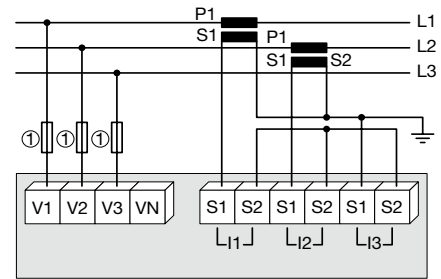

Use of 2 CTs reduces by 0.5% the accuracy of the phases, the current of which is worked out by vector calculation.

1. Fuses 0.5 A gG / 0.5 A class CC.

Low voltage unbalanced network

2 wires with 2 CTs

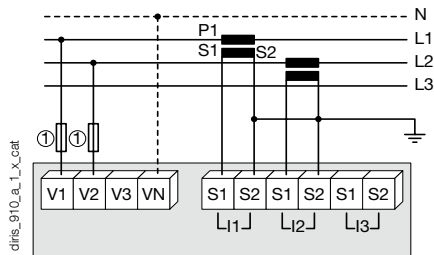

1. Fuses 0.5 A gG / 0.5 A class CC.

Additional information

Communication via RS485 link

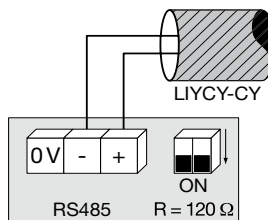

AC & DC auxiliary power supply

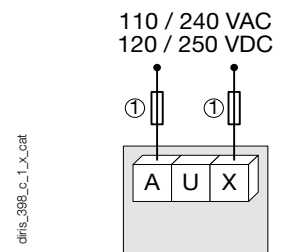

1. Fuses 0.5 A gG / 0.5 A class CC.

References

| | |
|---|------------------|
| Basic device | DIRIS A20 |
| Auxiliary power supply U_s | Reference |
| 110 ... 240 VAC / 120 ... 250 VDC | 4825 U200 |
| Optional plug-in modules | Reference |
| 1 output | 4825 0080 |
| RS485 MODBUS® communication | 4825 0082 |